

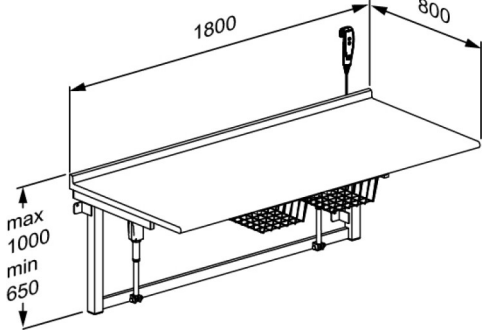

<b>Product</b> <b>Item number</b>	Changing table, 800 x 1800 mm, electrically height adjustable R8713000
<b>Colour</b>  <b>Product description</b>	<p>VVS:777630030          NRF:7501912          EAN:5708590286204          HMI: 48863</p> <p>White</p>  <p>Pressalit offers a wide range of daycare changing tables, both free-standing and wall-hung, in several sizes and models. The wall-hung tables are also available in versions where the worktop folds away, which are suitable for rooms with limited space. Of particular use to daycare facilities and kindergartens are the low start wall-hung changing tables, which can be lowered to a height that allows children to climb onto the worktop themselves. All types of daycare changing tables are available in versions with sanitary appliances and a choice of taps, with or without pull-out shower heads.</p> <p>Wallhung changing table, 800 x 1800 mm.          With electric motor and transformer, height adjustable from 650 mm - 1000 mm, with wired hand control.          Laminate worktop, incl. 2 wire baskets.          Materials: Laminate and powder-lacquered steel.          Excl. mounting kit.</p>
<b>Adjustability</b> <b>Adjustment height</b>  <b>Product capacity</b> <b>Speed upwards</b>  <b>Noise level</b>	Height adjustable 350 mm  Max load: 150 kg. Speed up mm: 14 mm/s Speed down mm: 14 mm/s  48 dB
<b>Materials</b>  <b>Ergonomy</b>	Lifting unit and baskets: Powder-laquered steel. Worktop: Melamine  The smooth height adjustment ensures that it is always possible to set the table at an ergonomically correct height.



<b>Product</b>	Changing table, 800 x 1800 mm, electrically height adjustable
<b>Item number</b>	R8713000
<b>Features</b>	Easy-to-clean surfaces ensure optimum hygiene.
<b>Mains connection (V)</b>	230
<b>Actuator (motor)</b>	2 x LA31 Deskline (Linak), 1500N, IPX1
<b>Control box</b>	CBD6 (Linak), IP20
<b>Wired remote control</b>	HB30 (Linak), IPX4
<b>Power consumption (maximum load)</b>	Power consumption by maximum load, watt: 96 W Power consumption by standby: 0,1 W
<b>Warranty</b>	Pressalit makes a commitment to remedy material and manufacturing defects for a period of three years from the invoicing date.
<b>Cleaning</b>	<p>Daycare changing tables The product is to be cleaned with hot water or a mild soapy cleaning agent. Do not use chlorine based, corrosive or abrasive cleaners as it may result in the surface being damaged.</p> <p>The following cleaning agents have been tested by Pressalit and may be used, as long as they are diluted according to the instructions on the container.</p> <p><b>DISINFECTANTS:</b> Clinimax Difficil-S Erisan OXY+ Sprit (husholdningsprit) Suma Bac D10 Virkon Rodalon Desinfektionsspray Lysoformin Spezial CaviCide Sufanios Premium Tvättsprit 70%</p> <p><b>NON-DISINFECTANTS:</b> Suma Star free D1 Taski 100 Taski 200 Milizid Citro</p> <p>The product must be wiped down with a soft rag wrung out in clear water immediately after cleaning, as some materials may otherwise be discolored and stained, and the surface coating may deteriorate.</p>





PRESSALIT®

<b>Product</b>	Changing table, 800 x 1800 mm, electrically height adjustable
<b>Item number</b>	R8713000
<b>Declaration of conformity</b>	<p>CE UK MASK-ROHS This product complies with the relevant requirements of:</p> <ul style="list-style-type: none"><li>- Council Directive 2006/42/EC on machinery</li><li>- Council Directive 2011/65/EC on RoHS.</li></ul> <p><b>For the UK:</b> - The Supply of Machinery (Safety) Regulations 2008</p> <ul style="list-style-type: none"><li>- Restriction of the Use of Certain Hazardous Substances in Electrical and Electronic Equipment Regulations 2012</li></ul>

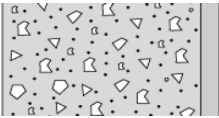
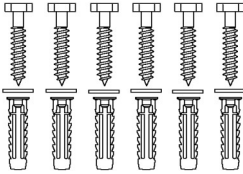

<b>Product</b>	Changing table, 800 x 1800 mm, electrically height adjustable
<b>Item number</b>	R8713000

## Installation in different wall types

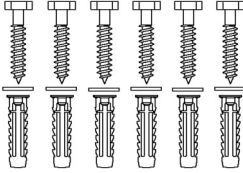
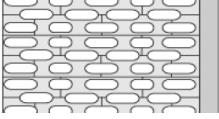
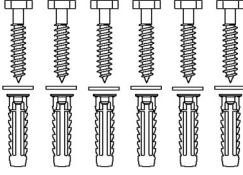
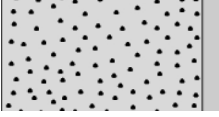
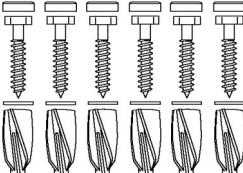
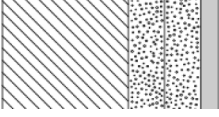
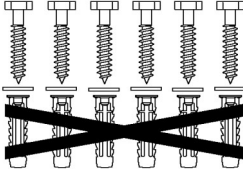
	<b>Concrete &gt;B25</b> V8608 - Mounting kit, 6 coach screws Ø10 x 70 - plugs SX12. To be ordered separately.	
	<b>Solid Brick &gt;= Mz12</b> V8608 - Mounting kit, 6 coach screws Ø10 x 70 - plugs SX12. To be ordered separately.	
	<b>Solid Sand Lime Brick &gt;= Hlz12</b> V8608 - Mounting kit, 6 coach screws Ø10 x 70 - plugs SX12. To be ordered separately.	
	<b>Aerated Concrete P4</b> V8658 - Mounting kit, 6 coach screws Ø10 x 70 - plugs GB14. To be ordered separately.	
	<b>Drywall (2 x 12,5 mm) water-resistant, re-enforced with wood</b> V8608 - Mounting kit, 6 coach screws Ø10 x 70 - plugs SX12. NB! Plugs are not needed. To be ordered separately.	

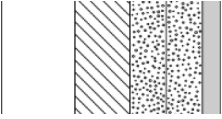
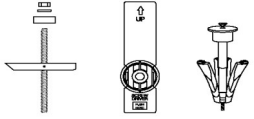
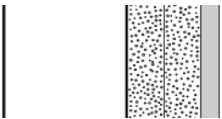
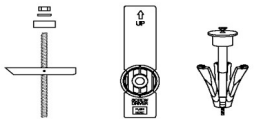
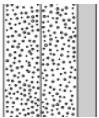

<b>Product</b> <b>Item number</b>	Changing table, 800 x 1800 mm, electrically height adjustable R8713000	
	<b>Drywall (2 x 12,5 mm) water-resistant, re-enforced with 22 mm plywood</b> Wall fasteners (6 pcs) must be bought separately, for drywall it is possible to use e.g. fischer KD8 toggles or similar.	
	<b>Drywall (2 x 12,5 mm) water-resistant, re-enforced with steel plates (2 mm)</b> Wall fasteners (6 pcs) must be bought separately, for drywall it is possible to use e.g. fischer KD8 toggles or similar.	
	<b>Drywall (2 x 12,5 mm) water-resistant</b> Mounting in this wall type is not recommended - risk of fatal injury to persons and walls.	