

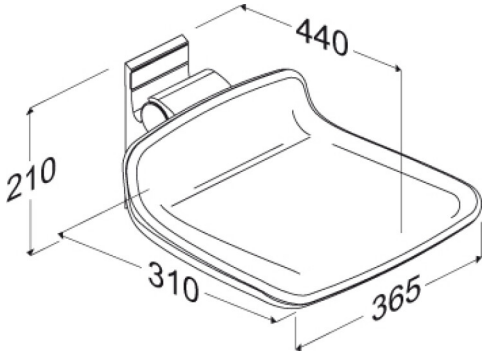

<p><b>Product</b> <b>Item number</b></p>	<p>PLUS shower seat 310, fixed height R7304112</p>
<p><b>Colour</b>  <b>Product description</b></p>	<p>VVS:777513012 NRF:6317087 EAN:5708590359328 HMI: 121181 FDA:INN/D135865 Anthracite grey</p>  <p>PLUS shower seats are offered in a number of colours. They are available as both fixed height, electrically adjustable and manually adjustable, and with an option of back and armrests. They are suitable for wall-mounting or for fitting to Pressalit PLUS wall tracks.</p> <p>PLUS shower seat 310. For fixed mounting. The seat is foldable. Materials: Comfortable polyurethane foam over a plywood core, fitted to an aluminium profile. Excl. mounting kit. <i>Replaces R7310</i></p>
<p><b>Adjustability</b> <b>Product capacity</b></p>	<p>Fixed mounting</p> <p>Maximum user mass: 200 kg. When the seat is loaded with 200 kg, each wall fastener is loaded with 113 kg.</p> <p><i>The seat has been tested statically with safety factor 1.5, which is a requirement according to the applied assistive products standards.</i></p>
<p><b>Materials</b>  <b>Ergonomy</b>  <b>Features</b></p>	<p>The shower seat is made of polyurethane (PU) foam with a plywood core and this is covered with an in-mould coated surface that is protected using a clear PU lacquer. Internal components and fasteners are primarily made of stainless steel. The hinge barrel is capped with ABS.</p> <p>Ergonomically designed seat - contact surface are 450 x 437 mm. Soft and slip-resistant material that has a warm feel.</p> <p>The seat can fold up when not in use or to maximise floor space.</p>
<p><b>Warranty</b></p>	<p>Pressalit makes a commitment to remedy material and manufacturing defects for a period of five years from the invoicing date.</p>





<b>Product</b>	PLUS shower seat 310, fixed height
<b>Item number</b>	R7304112
<b>Cleaning</b>	<p>PLUS shower seat The product is to be cleaned with hot water or a mild soapy cleaning agent. Do not use chlorine based, corrosive or abrasive cleaners as it may result in the surface being damaged.</p> <p>The following cleaning agents have been tested by Pressalit and may be used, as long as they are diluted according to the instructions on the container.</p> <p><b>DISINFECTANTS:</b> Erisan OXY+ Tvättsprit 70% CaviCide surface disinfectant decontaminant cleaner Rodalon Desinfektionsspray Terralin protect (SCHÜLKE+) Dismonzon Plus (BODE Chemie GmbH)</p> <p><b>NON-DISINFECTANTS:</b> Wetrok Caledor (Wetrok) Petrosol Citro (Büfa)</p> <p>Important: Polyurethane surfaces of PLUS shower seats and PLUS backrests contains an antibacterial surface, which will be compromised if cleaned with anything other than soap and water.</p> <p>The product must be wiped down with a soft rag wrung out in clear water immediately after cleaning, as some materials may otherwise be discolored and stained, and the surface coating may deteriorate.</p> <p><b>DECALCIFICATION OF ALUMINUM PARTS:</b> Pressalit recommends that chalky deposits be removed from wall tracks and other aluminum parts using a solution of three parts 30% acetic acid to seven parts tap water. When the aluminum parts have been washed down with this solution, the parts must be wiped over with a damp cloth wrung out in clear water.</p>
<b>Declaration of conformity</b>	CE MDR This product is in compliance with all relevant requirements of: - Regulation (EU) 2017/745 on medical devices.



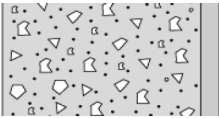
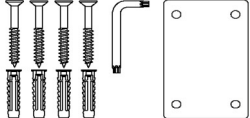

<b>Product</b>	PLUS shower seat 310, fixed height
<b>Item number</b>	R7304112

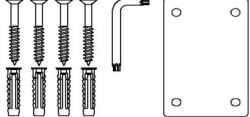
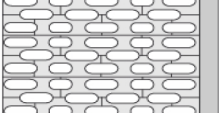
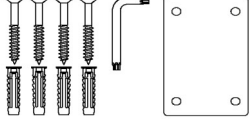
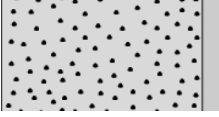
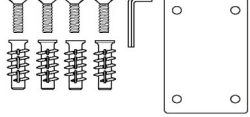
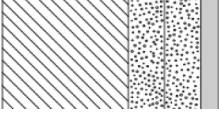
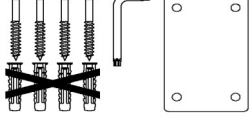
## Installation in different wall types

	<b>Concrete &gt;B25</b> V8604 - Mounting kit, 4 countersunk screws Ø8 x 70, plugs SX10. To be ordered separately.	
	<b>Solid Brick &gt;= Mz12</b> V8604 - Mounting kit, 4 countersunk screws Ø8 x 70, plugs SX10. To be ordered separately.	
	<b>Solid Sand Lime Brick &gt;= Hlz12</b> V8604 - Mounting kit, 4 countersunk screws Ø8 x 70, plugs SX10. To be ordered separately.	
	<b>Aerated Concrete P4</b> V8654 - Mounting kit, 4 countersunk bolts M8 x 35, plugs FTP M 8. To be ordered separately.	
	<b>Drywall (2 x 12,5 mm) water-resistant, re-enforced with wood</b> V8604 - Mounting kit, 4 countersunk screws Ø8 x 70, plugs SX10. NB! Plugs are not needed. To be ordered separately.	

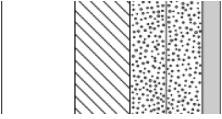
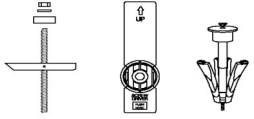
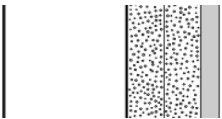
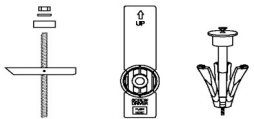
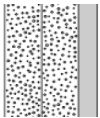

<b>Product</b> <b>Item number</b>	PLUS shower seat 310, fixed height R7304112
	<b>Drywall (2 x 12,5 mm) water-resistant, re-enforced with 22 mm plywood</b> Wall fasteners (4 pcs) must be bought separately, for drywall it is possible to use e.g. fischer KD8 toggles or similar. 
	<b>Drywall (2 x 12,5 mm) water-resistant, re-enforced with steel plates (2 mm)</b> Wall fasteners (4 pcs) must be bought separately, for drywall it is possible to use e.g. fischer KD8 toggles or similar. 
	<b>Drywall (2 x 12,5 mm) water-resistant</b> Mounting in this wall type is not recommended - risk of fatal injury to persons and walls. 

It is the responsibility of the installer to ensure that suitable wall fasteners are used.