

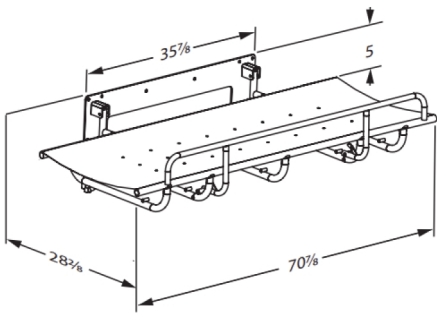

<p><b>Product</b> <b>Item number</b></p>	<p>SCT 1000 shower change table, fixed height R8407000</p>
<p><b>Color</b>  <b>Product description</b></p>	<p>VVS:777545380 RSK:8565078 EAN:5708590294827 HMI: 147800 NBS:N13:40,375 FDA:INT/D124320 White</p>  <p>Pressalit offers a variety of mobile and wall-hung, height-adjustable and fixed height shower and changing tables of high quality. They are designed to provide a stable platform for showering and changing adults and children with reduced mobility. These tables can be used in schools, institutions, hospitals and private homes and are all designed to be durable, comfortable and easy to clean. The design and flexibility of the tables ensures optimal working conditions for the carer as well as a high level of comfort and safety for the user.</p> <p>SCT 1000 shower change table, fixed height. Foldable. Incl. safety rail. Outer measurements 29.4" x 70.9". Excl. mounting kit.</p>
<p><b>Adjustability</b> <b>Product capacity</b></p>	<p>Fixed mounting</p> <p>Maximum user weight (MUM): 331 lbs. Maximum load (SWL): 331 lbs. When the table is loaded with 331 lbs, each mounting bolt supports 101 lbs. <i>This product has been tested statically with a load of 496 lbs as the ISO 17966 standard requires testing with a safety factor 1.5.</i></p>
<p><b>Materials</b> <b>Ergonomy</b> <b>Features</b></p>	<p>The table is made from practical and durable PVC canvas which is phthalate free. The frame is powder-coated steel.</p> <p>Foldable</p> <p>The integrated pneumatic cylinders enable the table to be folded out of the way when not in use to maximize floor space in front of the unit. Splash curtain (optional) for the changing table protects the caregiver against splashing.</p>





<b>Product</b>	SCT 1000 shower change table, fixed height
<b>Item number</b>	R8407000
<b>Warranty</b>	<p>Pressalit makes a commitment to remedy material and manufacturing defects for a period of three years from the invoicing date. NOTICE If the product is placed in an atmosphere heavy in salt or chloride, the warranty will be reduced from the normal 3 years to 1 year. Salt and chloride have a corrosive effect on the products components and will cause a decrease in the life expectancy of the product.</p>
<b>Cleaning</b>	<p>This product should be cleaned with hot water or a mild cleaning solution. Do not use chlorine based, corrosive or abrasive cleaners as it may result in the surface being damaged.</p> <p>The following cleaning agents have been tested by Pressalit and may be used, as long as they are diluted according to the instructions on the container.</p> <p><b>DISINFECTANTS:</b> Clinimax Difficil-S Erisan OXY+ Sprit (husholdningssprit) Suma Bac D10 Virkon Rodalon Desinfektionsspray Lysoformin Spezial CaviCide Sufanios Premium Tvättsprit 70% Accel PREvention Wipes Lingettes OxiGenesis from ENVIROX</p> <p><b>NON-DISINFECTANTS:</b> Suma Star free D1 Taski 100 Taski 200 Milizid Citro</p> <p>The product must be wiped down with a soft rag wrung out in clear water immediately after cleaning, as some materials may otherwise be discolored and stained, and the surface coating may deteriorate.</p>



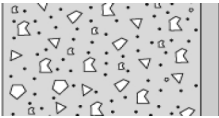
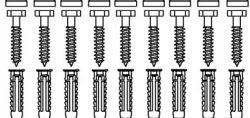

<b>Product</b>	SCT 1000 shower change table, fixed height
<b>Item number</b>	R8407000

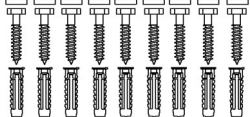
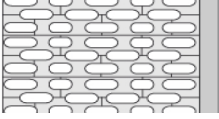
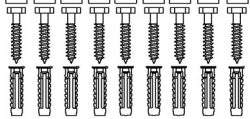
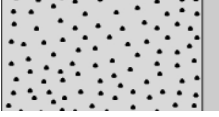
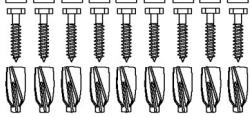
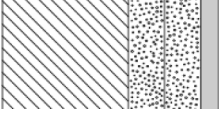
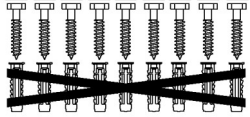
## Mounting in different wall types

	<b>Concrete &gt;B25</b> V8611 - Mounting kit, 9 hex bolts Ø10 x 70 - plugs SX12. To be ordered separately.	
	<b>Solid Brick &gt;= Mz12</b> V8611 - Mounting kit, 9 hex bolts Ø10 x 70 - plugs SX12. To be ordered separately.	
	<b>Solid Sand Lime Brick &gt;= Hlz12</b> V8611 - Mounting kit, 9 hex bolts Ø10 x 70 - plugs SX12. To be ordered separately.	
	<b>Aerated Concrete P4</b> V8661 - Mounting kit, 8 bolts M5 x 50 - plugs FTP K 6. To be ordered separately.	
	<b>Drywall (2 x 12,5 mm) water-resistant, re-enforced with wood</b> V8611 - Mounting kit, 8 bolts Ø5 x 50 - plugs SX8. NB! Plugs are not needed. To be ordered separately.	

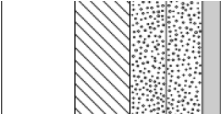
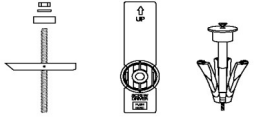
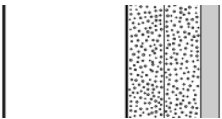
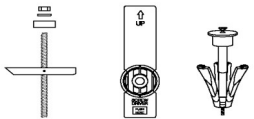
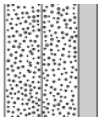

<b>Product</b> <b>Item number</b>	SCT 1000 shower change table, fixed height R8407000	
	<b>Drywall (2 x 12,5 mm) water-resistant, re-enforced with 22 mm plywood</b> Wall fasteners (9 pcs) must be bought separately, for drywall it is possible to use e.g. SnapTight or WingIt anchors or similar.	
	<b>Drywall (2 x 12,5 mm) water-resistant, re-enforced with steel plates (.08 inch)</b> Wall fasteners (9 pcs) must be bought separately, for drywall it is possible to use e.g. SnapTight or WingIt anchors or similar.	
	<b>Drywall (2 x 12,5 mm) water-resistant</b> Mounting in this wall type is not recommended - risk of fatal injury to persons and walls.	

It is the responsibility of the installer to ensure that suitable wall fasteners are used.