

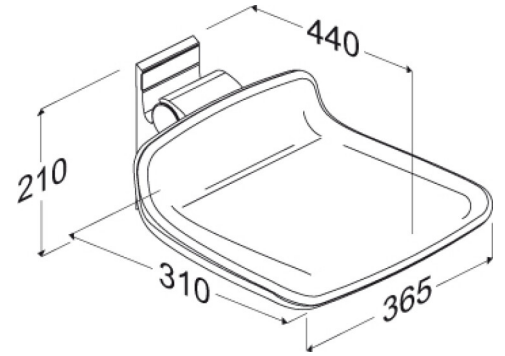

<p>Product Item number</p>	<p>PLUS shower seat 310, fixed height R7304108</p>
<p>Colour Product description</p>	<p>NRF:6317086 EAN:5708590359311 HMI: 121181 FDA:INN/D135865</p> <p>Dark blue (RAL 5011)</p> <p>PLUS shower seats are offered in a number of colours. They are available as both fixed height, electrically adjustable and manually adjustable, and with an option of back and armrests. They are suitable for wall-mounting or for fitting to Pressalit PLUS wall tracks.</p> <p>PLUS shower seat 310. For fixed mounting. The seat is foldable. Materials: Comfortable polyurethane foam over a plywood core, fitted to an aluminium profile. Excl. mounting kit. <i>Replaces R7310</i></p>
<p>Adjustability Product capacity</p>	<p>Fixed mounting</p> <p>Maximum user mass: 200 kg. When the seat is loaded with 200 kg, each wall fastener is loaded with 113 kg.</p> <p><i>The seat has been tested statically with safety factor 1.5, which is a requirement according to the applied assistive products standards.</i></p>
<p>Materials Ergonomy Features</p>	<p>The shower seat is made of polyurethane (PU) foam with a plywood core and this is covered with an in-mould coated surface that is protected using a clear PU lacquer. Internal components and fasteners are primarily made of stainless steel. The hinge barrel is capped with ABS.</p> <p>Ergonomically designed seat - contact surface are 450 x 437 mm. Soft and slip-resistant material that has a warm feel.</p> <p>The seat can fold up when not in use or to maximise floor space.</p>
<p>Warranty</p>	<p>Pressalit makes a commitment to remedy material and manufacturing defects for a period of five years from the invoicing date.</p>







Product	PLUS shower seat 310, fixed height
Item number	R7304108
Cleaning	<p>PLUS shower seat The product is to be cleaned with hot water or a mild soapy cleaning agent. Do not use chlorine based, corrosive or abrasive cleaners as it may result in the surface being damaged.</p> <p>The following cleaning agents have been tested by Pressalit and may be used, as long as they are diluted according to the instructions on the container.</p> <p>DISINFECTANTS: Erisan OXY+ Tvättsprit 70% CaviCide surface disinfectant decontaminant cleaner Rodalon Desinfektionsspray Terralin protect (SCHÜLKE+) Disonzon Plus (BODE Chemie GmbH)</p> <p>NON-DISINFECTANTS: Wetrok Caledor (Wetrok) Petrosol Citro (Büfa)</p> <p>Important: Polyurethane surfaces of PLUS shower seats and PLUS backrests contains an antibacterial surface, which will be compromised if cleaned with anything other than soap and water.</p> <p>The product must be wiped down with a soft rag wrung out in clear water immediately after cleaning, as some materials may otherwise be discolored and stained, and the surface coating may deteriorate.</p> <p>DECALCIFICATION OF ALUMINUM PARTS: Pressalit recommends that chalky deposits be removed from wall tracks and other aluminum parts using a solution of three parts 30% acetic acid to seven parts tap water. When the aluminum parts have been washed down with this solution, the parts must be wiped over with a damp cloth wrung out in clear water.</p>
Declaration of conformity	CE MDR This product is in compliance with all relevant requirements of: - Regulation (EU) 2017/745 on medical devices.



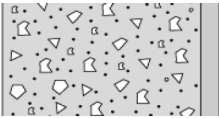
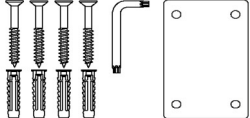

Product	PLUS shower seat 310, fixed height
Item number	R7304108

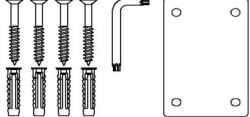
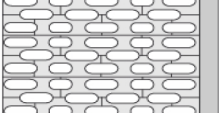
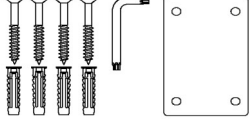
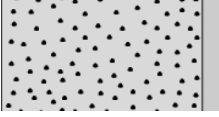
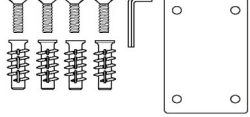
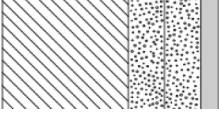
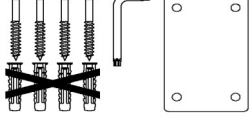
Installation in different wall types

	Concrete >B25 V8604 - Mounting kit, 4 countersunk screws Ø8 x 70, plugs SX10. To be ordered separately.	
	Solid Brick >= Mz12 V8604 - Mounting kit, 4 countersunk screws Ø8 x 70, plugs SX10. To be ordered separately.	
	Solid Sand Lime Brick >= Hlz12 V8604 - Mounting kit, 4 countersunk screws Ø8 x 70, plugs SX10. To be ordered separately.	
	Aerated Concrete P4 V8654 - Mounting kit, 4 countersunk bolts M8 x 35, plugs FTP M 8. To be ordered separately.	
	Drywall (2 x 12,5 mm) water-resistant, re-enforced with wood V8604 - Mounting kit, 4 countersunk screws Ø8 x 70, plugs SX10. NB! Plugs are not needed. To be ordered separately.	

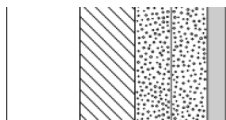
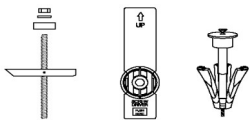
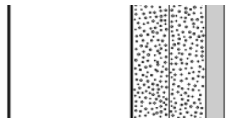
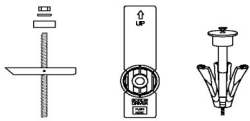
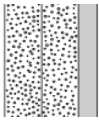

Product Item number	PLUS shower seat 310, fixed height R7304108
	Drywall (2 x 12,5 mm) water-resistant, re-enforced with 22 mm plywood Wall fasteners (4 pcs) must be bought separately, for drywall it is possible to use e.g. fischer KD8 toggles or similar. 
	Drywall (2 x 12,5 mm) water-resistant, re-enforced with steel plates (2 mm) Wall fasteners (4 pcs) must be bought separately, for drywall it is possible to use e.g. fischer KD8 toggles or similar. 
	Drywall (2 x 12,5 mm) water-resistant Mounting in this wall type is not recommended - risk of fatal injury to persons and walls. 

It is the responsibility of the installer to ensure that suitable wall fasteners are used.