

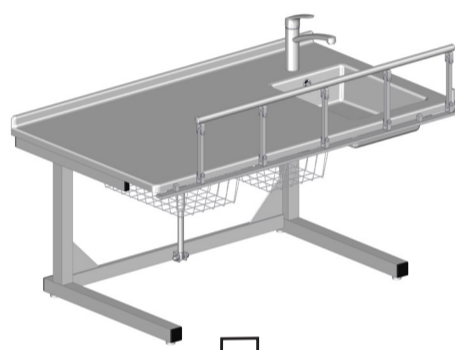

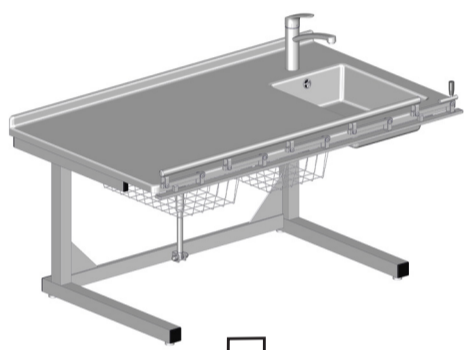

150 kg, 331 lbs

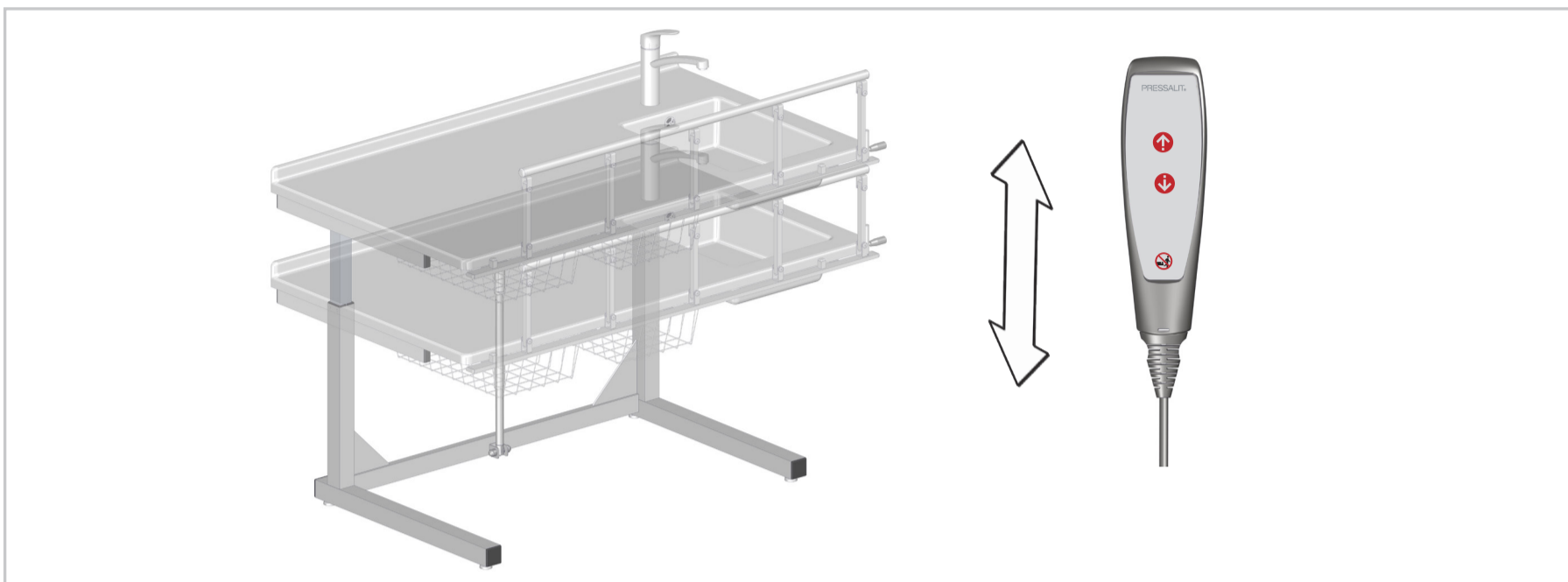

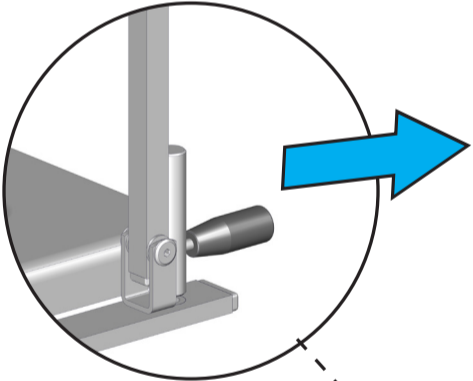

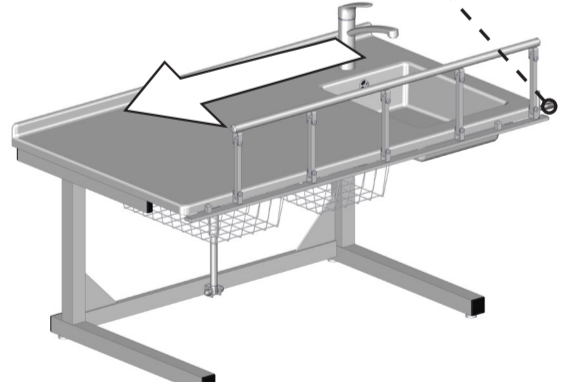
① 

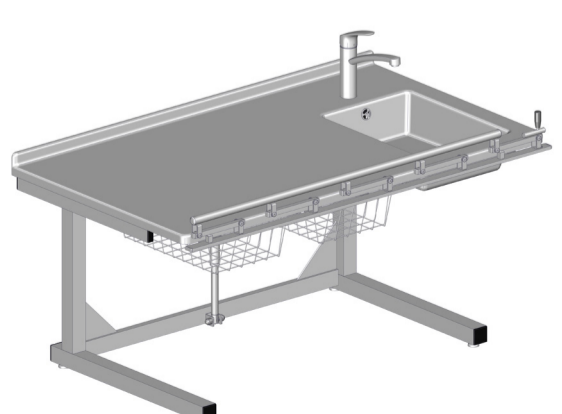
② 

③ 

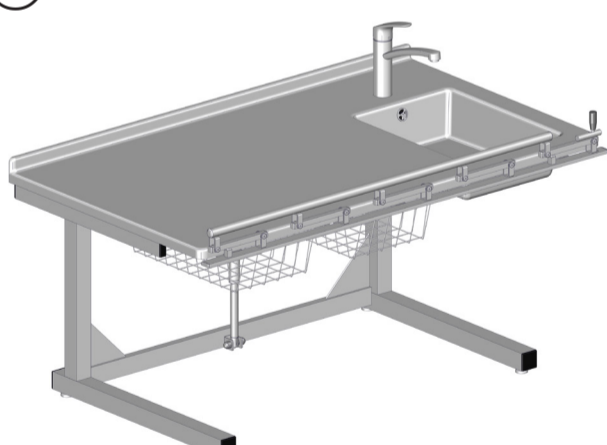

① 

② 