

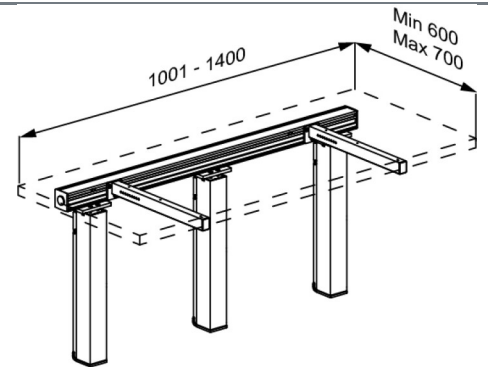

Product	INDIVO lift for worktop 1001-1400 mm
Item number	RK1451202
	EAN:5708590378916
Colour	Grey (RAL 9006)
Product description	<p>Pressalit INDIVO lifting units can be easily integrated into the private home, ensuring that the whole family can enjoy the full potential and use the height adjustable function. The lifting units can also help provide a flexible kitchen solution for e.g. care centers, school kitchens and school science labs, wherever there is a need for frequent height adjustments on kitchen worktops and cupboards.</p> <p>INDIVO lift for worktop, with three motors and control box. Incl. cross brace and two brackets. Height adjustable up to 300 mm with switch or wired remote control. For worktop length 1001-1400 mm. Please indicate length and depth of worktop when ordering. Excl. mounting kit.</p>
Adjustability	Height adjustable
Adjustment height	300 mm
Product capacity	Maximum load: 150 kg, this includes the weight of the worktop. The load must be evenly distributed.
Speed upwards	Speed up mm: 20 mm/s Speed down mm: 20 mm/s
Noise level	45 dB
Materials	Lifting columns: Powder-coated steel Cross brace: Aluminium Brackets: Powder-coated steel
Ergonomy	An electric height-adjustable kitchen worktop is ideal in all situations where various users - both seated and standing - use the same kitchen. This is equally true in private homes as well as larger centres with common kitchen facilities such as group homes and care centres.





Product	INDIVO lift for worktop 1001-1400 mm
Item number	RK1451202
Features	Lifts are height adjusted either via switches in the front edge or with a wired remote control.
Actuator (motor)	DL17 Deskline (Linak) 70N, IP20
Control box	CBD6S (Linak) IP20
Wired remote control	HB53 (Linak), IPX1
Power consumption (maximum load)	Power consumption by maximum load, watt: 300 W Power consumption by standby: 2 W
Warranty	Pressalit makes a commitment to remedy material and manufacturing defects for a period of three years from the invoicing date.





Product	INDIVO lift for worktop 1001-1400 mm
Item number	RK1451202
Cleaning	<p>The product is to be cleaned with hot water or a mild soapy cleaning agent. Do not use chlorine based, corrosive or abrasive cleaners as it may result in the surface being damaged.</p> <p>The following cleaning agents have been tested by Pressalit and may be used, as long as they are diluted according to the instructions on the container.</p> <p>DISINFECTANTS: Clinimax Difficil-S Erisan OXY+ Sprit (husholdningssprit) Suma Bac D10 Virkon Rodalon Desinfektionsspray Lysoformin Spezial CaviCide Sufanios Premium Tvättsprit 70%</p> <p>NON-DISINFECTANTS: Suma Star free D1 Taski 100 Taski 200 Milizid Citro</p> <p>The product must be wiped down with a soft rag wrung out in clear water immediately after cleaning, as some materials may otherwise be discolored and stained, and the surface coating may deteriorate.</p> <p>DECALCIFICATION OF ALUMINUM PARTS: Pressalit recommends that chalky deposits be removed from wall tracks and other aluminum parts using a solution of three parts 30% acetic acid to seven parts tap water. When the aluminum parts have been washed down with this solution, the parts must be wiped over with a damp cloth wrung out in clear water.</p>
WEEE	<p>Please enquire of your local Pressalit subsidiary or distributor (in countries where there is no subsidiary) that will arrange for recycling of electronic waste in accordance with the WEEE directive.</p>

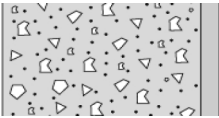
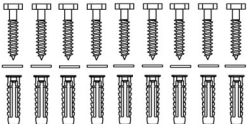

Product	INDIVO lift for worktop 1001-1400 mm
Item number	RK1451202

Installation in different wall types

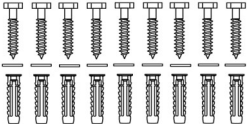
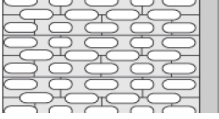
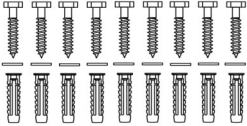
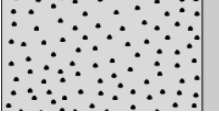
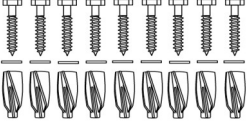
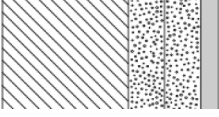
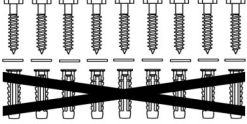
	Concrete >B25 V8607 - Mounting kit, 9 coach screws Ø10 x 70 - plugs SX12. To be ordered separately.	
	Solid Brick >= Mz12 V8607 - Mounting kit, 9 coach screws Ø10 x 70 - plugs SX12. To be ordered separately.	
	Solid Sand Lime Brick >= Hlz12 V8607 - Mounting kit, 9 coach screws Ø10 x 70 - plugs SX12. To be ordered separately.	
	Aerated Concrete P4 V8657 - Mounting kit, 9 coach screws Ø10 x 70 - plugs GB14. To be ordered separately.	
	Drywall (2 x 12,5 mm) water-resistant, re-enforced with wood V8607 - Mounting kit, 9 coach screws Ø10 x 70 - plugs SX12. NB! Plugs are not needed. To be ordered separately.	

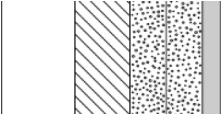
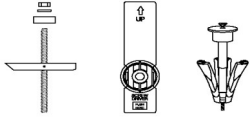
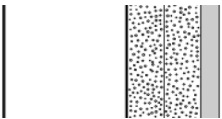
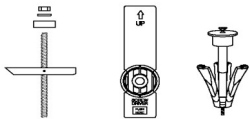
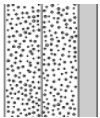
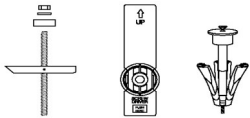

Product Item number	INDIVO lift for worktop 1001-1400 mm RK1451202
	Drywall (2 x 12,5 mm) water-resistant, re-enforced with 22 mm plywood Wall fasteners (9 pcs) must be bought separately, for drywall it is possible to use e.g. fischer KD8 toggles or similar. 
	Drywall (2 x 12,5 mm) water-resistant, re-enforced with steel plates (2 mm) Wall fasteners (9 pcs) must be bought separately, for drywall it is possible to use e.g. fischer KD8 toggles or similar. 
	Drywall (2 x 12,5 mm) water-resistant Wall fasteners (9 pcs) must be bought separately, for drywall it is possible to use e.g. fischer KD8 toggles or similar. 

It is the responsibility of the installer to ensure that suitable wall fasteners are used.