

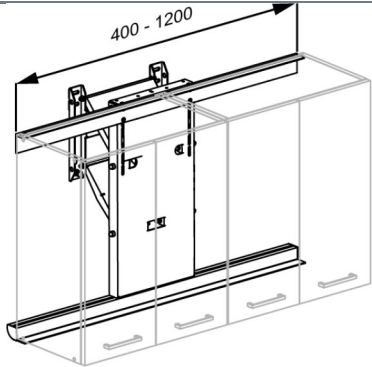

Product Item number	INDIVO lift for wall cupboards 400-1200 mm RK1420
Product description	EAN:5708590378862  <p>Pressalit INDIVO lifting units can be easily integrated into the private home, ensuring that the whole family can enjoy the full potential and use the height adjustable function. The lifting units can also help provide a flexible kitchen solution for e.g. care centers, school kitchens and school science labs, wherever there is a need for frequent height adjustments on kitchen worktops and cupboards.</p> <p>INDIVO lift for wall cupboards, with one motor and control box. Height adjustable 430 mm with switches or wired remote control. When height adjusting downward, the lift will also move 180 mm towards the user. For wall cupboards width 400-1200 mm. Please note: Maximum height of wall cupboards is 725 mm. If a wall cupboard is to be higher than this, an extension RK1065-RK1066 must be added. Please indicate height, width and depth of wall cupboards when ordering. Excl. mounting kit.</p>
Adjustability Adjustment height Product capacity Speed upwards Noise level	Height adjustable 430 mm Max. load (including cupboards): 1 lift: 110 kg Speed up mm: 18 mm/s Speed down mm: 18 mm/s 48 dB
Materials	Material: Lift motor: Steel Cross braces: Aluminium Switches: ABS plastic



Product	INDIVO lift for wall cupboards 400-1200 mm
Item number	RK1420
Ergonomy	<p>Wall cupboards are moved diagonally, that is both vertically and towards the user. This makes it easy for seated users and children to see and access covered contents.</p> <p>Height-adjustable wall cupboards provide extra storage options in kitchens where cupboards cannot be installed under worktops out of consideration for seated users.</p>
Features	<p>Lift heights for wall cupboards are adjusted via switches in the front worktop edge. Operating switches can be placed wherever you want along the front edge. The switches are colour-coded - aluminium to operate worktops, and red to operate wall cupboards.</p> <p>The design of the lifts ensures that the lift motors are as discreet as possible, regardless of the cupboard position.</p> <p>When the wall cupboards are lowered 430 mm to their lowest position, they are also extended 180 mm towards the user.</p>
Actuator (motor)	LA31 Deskline (Linak), 1500N, IPX1
Control box	CBD4 (Linak) IP22
Wired remote control	HB53 (Linak), IPX1
Power consumption (maximum load)	Power consumption by maximum load, watt: 187 W Power consumption by standby: 1,5 W
Warranty	Pressalit makes a commitment to remedy material and manufacturing defects for a period of three years from the invoicing date.



Product	INDIVO lift for wall cupboards 400-1200 mm
Item number	RK1420
Cleaning	<p>The product is to be cleaned with hot water or a mild soapy cleaning agent. Do not use chlorine based, corrosive or abrasive cleaners as it may result in the surface being damaged.</p> <p>The following cleaning agents have been tested by Pressalit and may be used, as long as they are diluted according to the instructions on the container.</p> <p>DISINFECTANTS: Clinimax Difficil-S Erisan OXY+ Sprit (husholdningssprit) Suma Bac D10 Virkon Rodalon Desinfektionsspray Lysoformin Spezial CaviCide Sufanios Premium Tvättsprit 70%</p> <p>NON-DISINFECTANTS: Suma Star free D1 Taski 100 Taski 200 Milizid Citro</p> <p>The product must be wiped down with a soft rag wrung out in clear water immediately after cleaning, as some materials may otherwise be discolored and stained, and the surface coating may deteriorate.</p> <p>DECALCIFICATION OF ALUMINUM PARTS: Pressalit recommends that chalky deposits be removed from wall tracks and other aluminum parts using a solution of three parts 30% acetic acid to seven parts tap water. When the aluminum parts have been washed down with this solution, the parts must be wiped over with a damp cloth wrung out in clear water.</p>
WEEE	<p>Please enquire of your local Pressalit subsidiary or distributor (in countries where there is no subsidiary) that will arrange for recycling of electronic waste in accordance with the WEEE directive.</p>







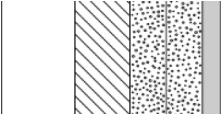
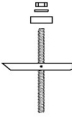

Product	INDIVO lift for wall cupboards 400-1200 mm
Item number	RK1420

Installation in different wall types

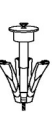
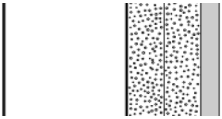
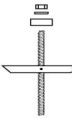
	<p>Concrete >B25 V8608 - Mounting kit, 6 coach screws Ø10 x 70 - plugs SX12. To be ordered separately.</p>	
	<p>Solid Brick >= Mz12 V8608 - Mounting kit, 6 coach screws Ø10 x 70 - plugs SX12. To be ordered separately.</p>	
	<p>Solid Sand Lime Brick >= Hlz12 V8608 - Mounting kit, 6 coach screws Ø10 x 70 - plugs SX12. To be ordered separately.</p>	
	<p>Aerated Concrete P4 V8658 - Mounting kit, 6 coach screws Ø10 x 70 - plugs GB14. To be ordered separately.</p>	
	<p>Drywall (2 x 12,5 mm) water-resistant, re-enforced with wood V8608 - Mounting kit, 6 coach screws Ø10 x 70 - plugs SX12. NB! Plugs are not needed. To be ordered separately.</p>	

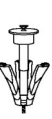
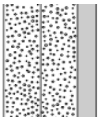
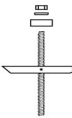

Product Item number	INDIVO lift for wall cupboards 400-1200 mm RK1420
	Drywall (2 x 12,5 mm) water-resistant, re-enforced with 22 mm plywood Wall fasteners (6 pcs) must be bought separately, for drywall it is possible to use e.g. fischer KD8 toggles or similar.   
	Drywall (2 x 12,5 mm) water-resistant, re-enforced with steel plates (2 mm) Wall fasteners (6 pcs) must be bought separately, for drywall it is possible to use e.g. fischer KD8 toggles or similar.   
	Drywall (2 x 12,5 mm) water-resistant Wall fasteners (6 pcs) must be bought separately, for drywall it is possible to use e.g. fischer KD8 toggles or similar.   

It is the responsibility of the installer to ensure that suitable wall fasteners are used.