

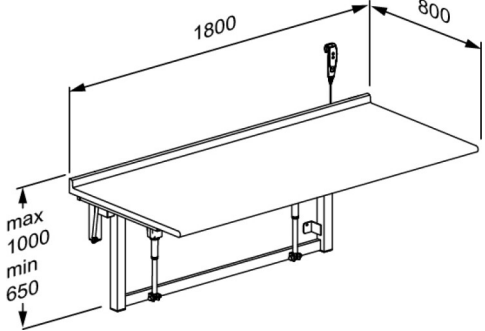

<b>Product</b> <b>Item number</b>	Changing table, 800 x 1800 mm, electrically height adjustable, foldable R8723000
<b>Colour</b>  <b>Product description</b>	<p>VVS:777630130          NRF:7501915          RSK:8565148          EAN:5708590286235          HMI: 48866          White</p>  <p>Pressalit offers a wide range of daycare changing tables, both free-standing and wall-hung, in several sizes and models. The wall-hung tables are also available in versions where the worktop folds away, which are suitable for rooms with limited space. Of particular use to daycare facilities and kindergartens are the low start wall-hung changing tables, which can be lowered to a height that allows children to climb onto the worktop themselves.</p> <p>All types of daycare changing tables are available in versions with sanitary appliances and a choice of taps, with or without pull-out shower heads.</p> <p>Wallhung, foldable changing table, 800 x 1800 mm.          With electric motor and transformer, height adjustable from 650 mm - 1000 mm, with wired hand control.          Materials: Worktop in laminate and powder-lacquered steel.          Excl. mounting kit.</p>
<b>Adjustability</b> <b>Adjustment height</b>  <b>Product capacity</b> <b>Speed upwards</b>  <b>Noise level</b>	Height adjustable 350 mm  Max load: 150 kg. Speed up mm: 14 mm/s Speed down mm: 14 mm/s  48 dB
<b>Materials</b>  <b>Ergonomy</b>	Lifting unit: Powder-laquered steel. Worktop: Melamine  The smooth height adjustment ensures that it is always possible to set the table at an ergonomically correct height.



<b>Product</b>	Changing table, 800 x 1800 mm, electrically height adjustable, foldable
<b>Item number</b>	R8723000
<b>Features</b>	Easy-to-clean surfaces ensure optimum hygiene. The integrated gas cylinder enables the table to be folded easily against the wall when not in use to maximise floor space.
<b>Mains connection (V)</b>	230
<b>Actuator (motor)</b>	2 x LA31 Deskline (Linak), 1500N, IPX1
<b>Control box</b>	CBD6 (Linak), IP20
<b>Wired remote control</b>	HB30 (Linak), IPX4
<b>Power consumption (maximum load)</b>	Power consumption by maximum load, watt: 96 W Power consumption by standby: 0,1 W
<b>Warranty</b>	Pressalit makes a commitment to remedy material and manufacturing defects for a period of three years from the invoicing date.





<b>Product</b>	Changing table, 800 x 1800 mm, electrically height adjustable, foldable
<b>Item number</b>	R8723000
<b>Cleaning</b>	<p>The product is to be cleaned with hot water or a mild soapy cleaning agent. Do not use chlorine based, corrosive or abrasive cleaners as it may result in the surface being damaged.</p> <p>The following cleaning agents have been tested by Pressalit and may be used, as long as they are diluted according to the instructions on the container.</p> <p><b>DISINFECTANTS:</b> Clinimax Difficil-S Erisan OXY+ Sprit (husholdningssprit) Suma Bac D10 Virkon Rodalon Desinfektionsspray Lysoformin Spezial CaviCide Sufanios Premium Tvättsprit 70%</p> <p><b>NON-DISINFECTANTS:</b> Suma Star free D1 Taski 100 Taski 200 Milizid Citro</p> <p>The product must be wiped down with a soft rag wrung out in clear water immediately after cleaning, as some materials may otherwise be discolored and stained, and the surface coating may deteriorate.</p>
<b>WEEE</b>	Please enquire of your local Pressalit subsidiary or distributor (in countries where there is no subsidiary) that will arrange for recycling of electronic waste in accordance with the WEEE directive.

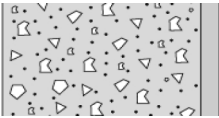
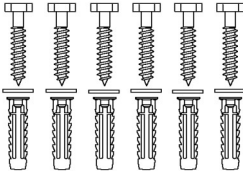

<b>Product</b>	Changing table, 800 x 1800 mm, electrically height adjustable, foldable
<b>Item number</b>	R8723000

## Installation in different wall types

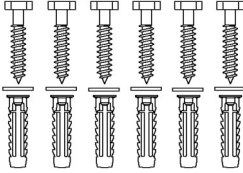
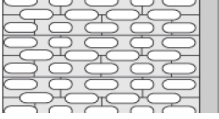
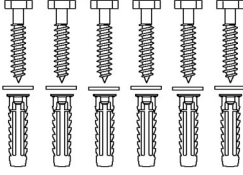
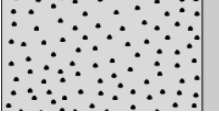
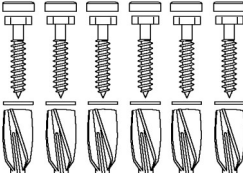
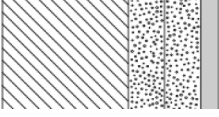
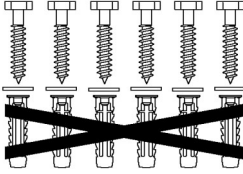
	<b>Concrete &gt;B25</b> V8608 - Mounting kit, 6 coach screws Ø10 x 70 - plugs SX12. To be ordered separately.	
	<b>Solid Brick &gt;= Mz12</b> V8608 - Mounting kit, 6 coach screws Ø10 x 70 - plugs SX12. To be ordered separately.	
	<b>Solid Sand Lime Brick &gt;= Hlz12</b> V8608 - Mounting kit, 6 coach screws Ø10 x 70 - plugs SX12. To be ordered separately.	
	<b>Aerated Concrete P4</b> V8658 - Mounting kit, 6 coach screws Ø10 x 70 - plugs GB14. To be ordered separately.	
	<b>Drywall (2 x 12,5 mm) water-resistant, re-enforced with wood</b> V8608 - Mounting kit, 6 coach screws Ø10 x 70 - plugs SX12. NB! Plugs are not needed. To be ordered separately.	

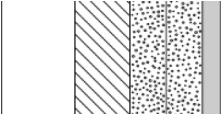
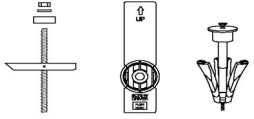
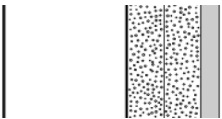
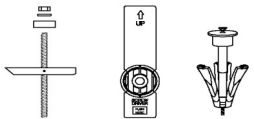
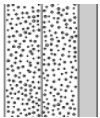

<b>Product</b> <b>Item number</b>	Changing table, 800 x 1800 mm, electrically height adjustable, foldable R8723000
	<b>Drywall (2 x 12,5 mm) water-resistant, re-enforced with 22 mm plywood</b> Wall fasteners (6 pcs) must be bought separately, for drywall it is possible to use e.g. fischer KD8 toggles or similar. 
	<b>Drywall (2 x 12,5 mm) water-resistant, re-enforced with steel plates (2 mm)</b> Wall fasteners (6 pcs) must be bought separately, for drywall it is possible to use e.g. fischer KD8 toggles or similar. 
	<b>Drywall (2 x 12,5 mm) water-resistant</b> Mounting in this wall type is not recommended - risk of fatal injury to persons and walls. 