

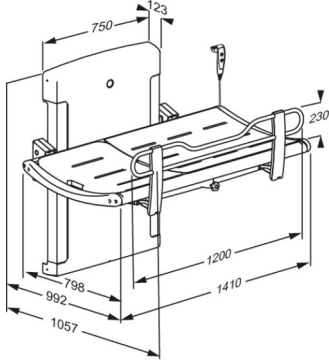

Product Item number	SCT 3000 shower change table, electrically height adjustable R8572313021
Colour Product description	EAN:5708590357485 Lead grey  <p>Pressalit offers a variety of mobile and wall-hung, height-adjustable and fixed height shower and changing tables of high quality. They are designed to provide a stable platform for showering and changing adults and children with reduced mobility. These tables can be used in schools, institutions, hospitals and private homes and are all designed to be durable, comfortable and easy to clean. The design and flexibility of the tables ensures optimal working conditions for the carer as well as a high level of comfort and safety for the user.</p> <p>The SCT 3000 series has a stylish and award-winning design focused on comfort and ease of use.</p> <p>SCT 3000 shower change table, powered, height adjustable 700 mm; from 300 mm - 1000 mm, with wired hand control Foldable. Incl. safety rail, flexible hose (Ø32 mm) and water collection tray with integrated outlet. Surface length 1300 mm, outer measurements 1057 mm x 1410 mm. Excl. mounting kit.</p>
Adjustability Adjustment height Product capacity Speed upwards Noise level	Height adjustable 700 mm Maximum user weight (MUM): 227 kg. Safe working load (SWL): 237 kg. When the table is loaded with 227 kg, each mounting bolt supports 29,5 kg <i>This product has been tested statically with a load of 592,5 kg as the IEC 60601-1 standard requires testing with safety factor 2.5.</i> Speed up mm: 15 mm/s Speed down mm: 20 mm/s 48 dB



Product	SCT 3000 shower change table, electrically height adjustable
Item number	R8572313021
Materials	Powder-lacquered stainless steel, aluminium and plastics (PVC, Polystyrene). Pads in polyurethane foam, are tested according to the DIN EN 1021-1 standard (flame resistance).
Ergonomy	<ul style="list-style-type: none">• The ergonomically designed safety rails have a practical lower central section, which provides better access and work environment for the carer while transferring, showering, drying, changing and dressing the user.• One hand operated safety rails allows the carer to maintain eye contact as well as physical contact with the user during the whole process.• Easy to clean, smooth contact surfaces which do not collect dirt and bacteria.
Features	<ul style="list-style-type: none">• A water collection tray with integrated water outlet prevents water from splashing on carers or the floor. The flexible hose (Ø32 mm) attached to the center mounted outlet of the water collection tray, can be connected to either an outlet in the floor or on the wall.• The slightly curved shape makes the table comfortable and safe to lie on.• Adjustable neck support which can be moved to either end of the 1800 mm shower and changing tables.• The integrated gas cylinders enable the table to be folded out of the way when not in use to maximize floor space.• The powered shower change table is supplied with a wired hand control. The red buttons clearly indicate "up" and "down".• The wired hand control comes with a practical holder for placement on the wall.
Mains connection (V)	230
Actuator (motor)	LA40 Careline (Linak) 4000 N, IPX6
Control box	CA63 Careline (Linak), IPX6
Wired remote control	HB30 (Linak), IP66
Power consumption (maximum load)	Power consumption by maximum load, watt: 420 W Power consumption by standby: 2 W



PRESSALIT®

Product	SCT 3000 shower change table, electrically height adjustable
Item number	R8572313021
Warranty	Pressalit makes a commitment to remedy material and manufacturing defects for a period of three years from the invoicing date. NOTICE If the product is placed in an atmosphere heavy in salt or chloride, the warranty will be reduced from the normal 3 years to 1 year. Salt and chloride have a corrosive effect on the products components and will cause a decrease in the life expectancy of the product.



Product	SCT 3000 shower change table, electrically height adjustable
Item number	R8572313021
Cleaning	<p>SCT 3000 The product is to be cleaned with hot water or a mild soapy cleaning agent. Do not use chlorine based, corrosive or abrasive cleaners as it may result in the surface being damaged.</p> <p>The following cleaning agents have been tested by Pressalit and may be used, as long as they are diluted according to the instructions on the container.</p> <p>DISINFECTANTS: Clinimax Difficil-S Erisan OXY+ Sprit (husholdningsprit) Suma Bac D10 Virkon Rodalon Desinfektionsspray Lysoformin Spezial CaviCide Sufanios Premium Tvättsprit 70% Accel PREvention Wipes Lingettes Universal Wipes (Clinell) Sporidical Wipes (Clinell) CHLOR-CLEAN Tablets (chemform) WipeClean Ethanol Disinfection 80% (PLUM) Wetwipe Ethanol Disinfection 70% (wetwipe) OxiGenesis from ENVIROX</p> <p>NON-DISINFECTANTS: Suma Star free D1 Taski 100 Taski 200 Milizid Citro</p> <p>The product must be wiped down with a soft rag wrung out in clear water immediately after cleaning, as some materials may otherwise be discolored and stained, and the surface coating may deteriorate.</p> <p>DECALCIFICATION OF ALUMINUM PARTS: Pressalit recommends that chalky deposits be removed from wall tracks and other aluminum parts using a solution of three parts 30% acetic acid to seven parts tap water. When the aluminum parts have been washed down with this solution, the parts must be wiped over with a damp cloth wrung out in clear water.</p>





PRESSALIT®

Product	SCT 3000 shower change table, electrically height adjustable
Item number	R8572313021
Declaration of conformity	<p>CE UK MDR-MASK-RoHS This product is in compliance with all relevant requirements of:</p> <ul style="list-style-type: none">- Regulation (EU) 2017/745 on medical devices- Council Directive 2006/42/EC on machinery- Council Directive 2011/65/EC on RoHS. For the UK:- Medical Device Regulation (MDR) 2002 on medical devices.- Supply of Machinery (Safety) Regulations 2008- Restriction of the Use of Certain Hazardous Substances in Electrical and Electronic Equipment Regulations 2012.



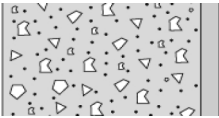
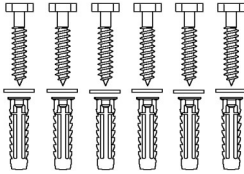

Product	SCT 3000 shower change table, electrically height adjustable
Item number	R8572313021

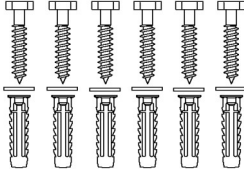
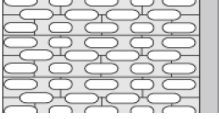
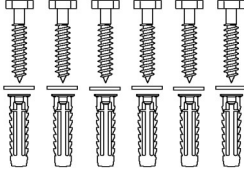
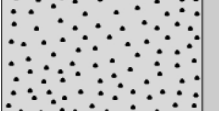
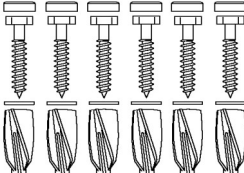
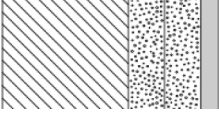
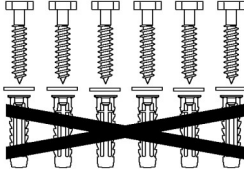
Installation in different wall types

	Concrete >B25 V8608 - Mounting kit, 6 coach screws Ø10 x 70 - plugs SX12. To be ordered separately.	
	Solid Brick >= Mz12 V8608 - Mounting kit, 6 coach screws Ø10 x 70 - plugs SX12. To be ordered separately.	
	Solid Sand Lime Brick >= Hlz12 V8608 - Mounting kit, 6 coach screws Ø10 x 70 - plugs SX12. To be ordered separately.	
	Aerated Concrete P4 V8658 - Mounting kit, 6 coach screws Ø10 x 70 - plugs GB14. To be ordered separately.	
	Drywall (2 x 12,5 mm) water-resistant, re-enforced with wood V8608 - Mounting kit, 6 coach screws Ø10 x 70 - plugs SX12. NB! Plugs are not needed. To be ordered separately.	

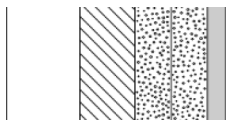
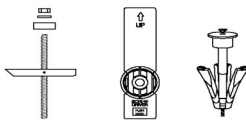
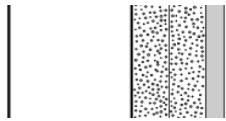
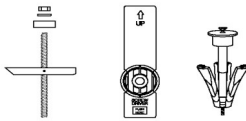
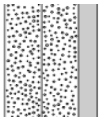

Product Item number	SCT 3000 shower change table, electrically height adjustable R8572313021	
	Drywall (2 x 12,5 mm) water-resistant, re-enforced with 22 mm plywood Wall fasteners (6 pcs) must be bought separately, for drywall it is possible to use e.g. fischer KD8 toggles or similar.	
	Drywall (2 x 12,5 mm) water-resistant, re-enforced with steel plates (2 mm) Wall fasteners (6 pcs) must be bought separately, for drywall it is possible to use e.g. fischer KD8 toggles or similar.	
	Drywall (2 x 12,5 mm) water-resistant Mounting in this wall type is not recommended - risk of fatal injury to persons and walls.	

It is the responsibility of the installer to ensure that suitable wall fasteners are used.